

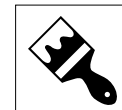

CLASSIC | MODERN

MAINTENANCE FREE RESIN OUTDOOR LIGHTING





MAINTENANCE
FREE

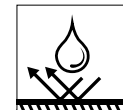

ANTI-RUST
FINISH



ANTI-SHOCK
BODY



FULLY
RECYCLABLE



UV RAY
TREATED

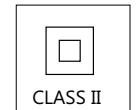

CLASS II
DOUBLE
INSULATION



ALL LED MODELS INCLUDE
TUV CERTIFIED LAMPS



MADE IN ITALY
SINCE 1973

© ECI Lighting 2020

eci
lighting



ABRAM 270

UP/DOWN
R7s LED WALL
LIGHT



SEE PAGE 43-44
FOR DETAILS

DECO

INSERT FOR
CARLO LED LIGHT



PAGES
39-40

LORENZA 270

RECESSED R7s
LED WALL LIGHT

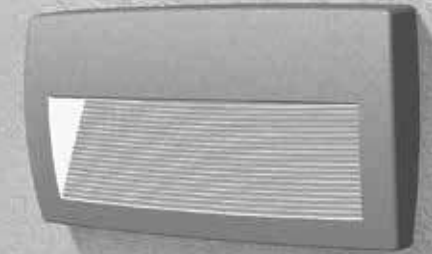

PAGE
59

G9 LAMPS
PAGE 81



ALDO

RECESSED/INGROUND
LED LIGHT



PAGE
55

GINO HP LED



















HIGH POWER LED
PUBLIC LIGHTING

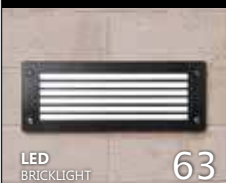

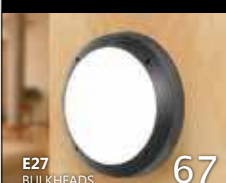
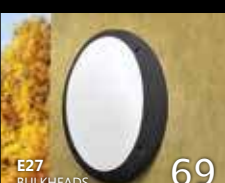
PAGES
77-78

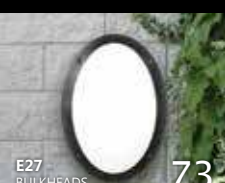
CLASSIC & MODERN RANGE

<p>ANNA</p>  <p>SMALL LANTERN 01</p>	<p>SABA</p>  <p>SMALL LANTERN 03</p>	<p>GLOBE 250</p>  <p>SMALL GLOBE 05</p>	<p>RUT</p>  <p>MEDIUM LANTERN 07</p>
<p>SALEM</p>  <p>MEDIUM LANTERN 09</p>	<p>GOLIA</p>  <p>MEDIUM LANTERN 11</p>	<p>CEFA</p>  <p>MEDIUM LANTERN 13</p>	<p>GLOBE 300</p>  <p>MEDIUM GLOBE 15</p>
<p>NOEMI</p>  <p>LARGE LANTERN 17</p>	<p>SILOE</p>  <p>LARGE LANTERN 19</p>	<p>TOBIA</p>  <p>LARGE LANTERN 21</p>	<p>SIMON</p>  <p>LARGE GLOBE 23</p>
<p>ELIA</p>  <p>LARGE LANTERN 25</p>	<p>GLOBE 400</p>  <p>LARGE GLOBE 27</p>	<p>IESSE/DARIA</p>  <p>HALF LANTERN 29</p>	<p>SAURO</p>  <p>E27/LED BOLLARDS 31</p>
<p>ESTER</p>  <p>LED BOLLARDS 33</p>	<p>ELISA</p>  <p>LED BOLLARDS 35</p>	<p>AMELIA</p>  <p>LED BOLLARDS 37</p>	<p>CARLO/DECO</p>  <p>LED BOLLARDS/INSERTS 39</p>

<p>FRANCA</p>  <p>LED CEILING/WALL 41</p>	<p>ABRAM</p>  <p>LED UP/DOWN 43</p>	<p>MARTA 90</p>  <p>LED UP/DOWN 45</p>	<p>MARTA 160</p>  <p>LED UP/DOWN 47</p>
<p>FRANCY/FRANCY OP</p>  <p>LED/E27 UP/DOWN 49</p>	<p>TOMMY/MINITOMMY</p>  <p>LED FLOODLIGHTS 51</p>	<p>GERMANA/GIUSEPPE</p>  <p>LED/E27 FLOODLIGHTS 53</p>	<p>ALDO/CECI</p>  <p>LED WALL/INGROUND 55</p>
<p>LORENZA/NINA</p>  <p>LED RECESSED 59</p>	<p>LETI 100</p>  <p>LED RECESSED 61</p>	<p>LETI/EXTRALETI 300</p>  <p>LED BRICKLIGHT 63</p>	<p>BERTA/BERTINA</p>  <p>LED BULKHEADS 65</p>
<p>GELMI</p>  <p>E27 BULKHEADS 67</p>	<p>DANZI</p>  <p>E27 BULKHEADS 69</p>	<p>LUCIA</p>  <p>E27 BULKHEADS 71</p>	<p>MADDI</p>  <p>E27 BULKHEADS 73</p>
<p>GABRI/MINIGABRI</p>  <p>BOLLARD RANGE 75</p>	<p>BEPPE/GINO</p>  <p>LARGE LED PUBLIC LIGHTING 77</p>	<p>POLES</p>  <p>CLASSIC & MODERN 79</p>	<p>LAMPS</p>  <p>FILAMENT/R7s G9/GX53/HIGH POWER 81</p>



BISSO ANNA



MINILOT ANNA













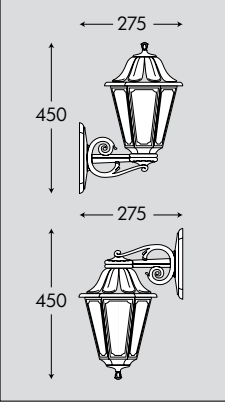
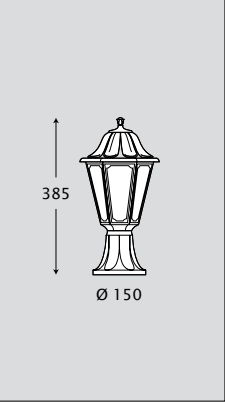
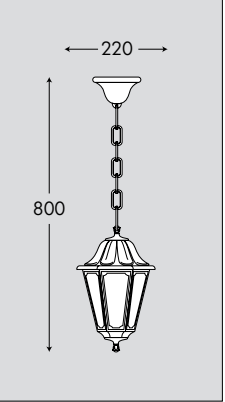
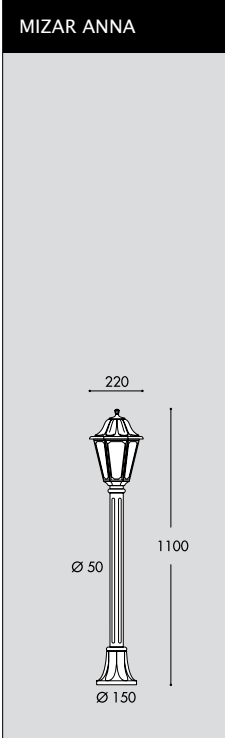
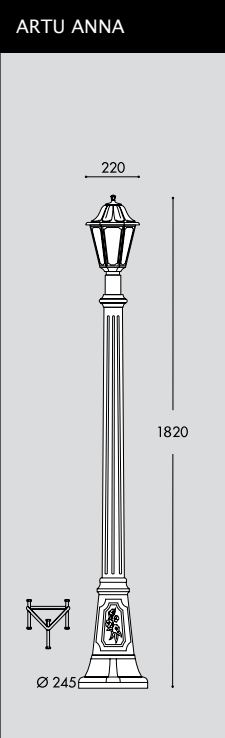
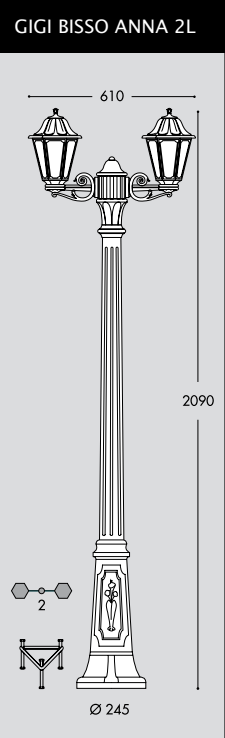
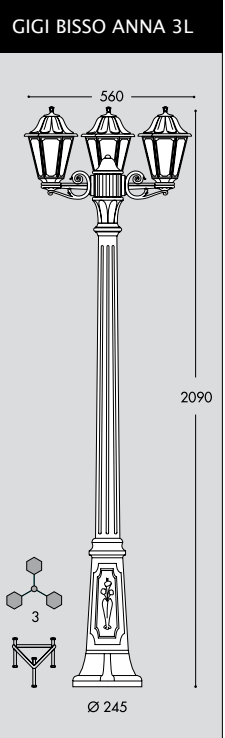

MIZAR ANNA



GIGI BISSO ANNA 2L



ANNA LANTERN	BISSO ANNA	MINILOT ANNA	SICHEM ANNA
 			
MIZAR ANNA	ARTU ANNA	GIGI BISSO ANNA 2L	GIGI BISSO ANNA 3L
			

- 
MAINTENANCE FREE
- 
ANTI-RUST FINISH
- 
ANTI-SHOCK BODY
- 
FULLY RECYCLABLE
- 
EUROPEAN CERTIFIED
- 
IP55 PROTECTION LEVEL
- 
UV RAY TREATED
- 
E27 LAMP BASE
- 
CLASS II DOUBLE INSULATION

OFFICIAL DISTRIBUTOR 



BISSO SABA



BISSO SABA

ARTU SABA



GIGI BISSO SABA 2L



SABA LANTERN	BISSO SABA	MINILOT SABA	SICHEM SABA
<p>BLACK</p>			
<p>MINILOT SABA</p>			
MIZAR SABA	ARTU SABA	GIGI BISSO SABA 2L	GIGI BISSO SABA 3L



- MAINTENANCE FREE
- ANTI-RUST FINISH
- ANTI-SHOCK BODY
- FULLY RECYCLABLE
- EUROPEAN CERTIFIED
- IP55 PROTECTION LEVEL
- UV RAY TREATED
- E27 LAMP BASE
- CLASS II DOUBLE INSULATION

OFFICIAL DISTRIBUTOR



BISSO
BRACKET
& OPAL
GLOBE 250



GLOBE 250 LANTERN	BISSO G250	MINILOT G250	SICHEM G250
<p>BLACK</p> <p>CLEAR</p> <p>SMOKED</p> <p>OPAL</p>	<p>360</p> <p>300</p> <p>Ø 250</p> <p>360</p> <p>300</p> <p>Ø 250</p>	<p>350</p> <p>Ø 250</p> <p>Ø 150</p>	<p>700</p> <p>Ø 250</p>
MIZAR G250	ARTU G250	GIGI BISSO G250 2L	GIGI BISSO G250 3L
<p>1000</p> <p>Ø 250</p> <p>Ø 50</p> <p>Ø 150</p>	<p>1710</p> <p>Ø 250</p> <p>Ø 245</p>	<p>2200</p> <p>670</p> <p>Ø 250</p> <p>Ø 245</p> <p>2</p>	<p>2200</p> <p>620</p> <p>Ø 250</p> <p>Ø 245</p> <p>3</p>

MAINTENANCE FREE	ANTI-RUST FINISH	ANTI-SHOCK BODY	FULLY RECYCLABLE	EUROPEAN CERTIFIED	PROTECTION LEVEL	UV RAY TREATED	E27 LAMP BASE	CLASS II DOUBLE INSULATION	OFFICIAL DISTRIBUTOR
------------------	------------------	-----------------	------------------	--------------------	------------------	----------------	---------------	----------------------------	----------------------



SICHEM RUT



RICU BISSO RUT 2L



MIZAR RUT



RICU BISSO RUT 3L

RUT LANTERN	BISSO RUT	MINILOT RUT	SICHEM RUT
MIZAR RUT	ARTU RUT	GIGI RUT	RICU BISSO RUT 2L/3L

									OFFICIAL DISTRIBUTOR
--	--	--	--	--	--	--	--	--	----------------------

MINILOT
BASE
& SALEM
LANTERN



SALEM LANTERN	BISSO SALEM	MINILOT SALEM	SICHEM SALEM
<p>BLACK</p> <p>MIZAR SALEM</p>			
MIZAR SALEM	ARTU/GIGI SALEM	RICU SALEM	RICU BISSO SALEM 2L/3L

MAINTENANCE FREE	ANTI-RUST FINISH	ANTI-SHOCK BODY	FULLY RECYCLABLE	EUROPEAN CERTIFIED	PROTECTION LEVEL	UV RAY TREATED	E27 LAMP BASE	CLASS II DOUBLE INSULATION	OFFICIAL DISTRIBUTOR
------------------	------------------	-----------------	------------------	--------------------	------------------	----------------	---------------	----------------------------	----------------------



BISSO
GOLIA



MIZAR
GOLIA



GIGI
GOLIA



RICCU
BISSO
GOLIA 3L



GOLIA LANTERN	BISSO GOLIA	MINILOT GOLIA	SICHEM GOLIA
MIZAR GOLIA	ARTU/GIGI GOLIA	RICU GOLIA	RICU BISSO GOLIA 2L/3L

MAINTENANCE FREE	ANTI-RUST FINISH	ANTI-SHOCK BODY	FULLY RECYCLABLE	EUROPEAN CERTIFIED	PROTECTION LEVEL	UV RAY TREATED	E27 LAMP BASE	CLASS II DOUBLE INSULATION	OFFICIAL DISTRIBUTOR
------------------	------------------	-----------------	------------------	--------------------	------------------	----------------	---------------	----------------------------	----------------------



BISSO
CEFA



SICHEM
CEFA

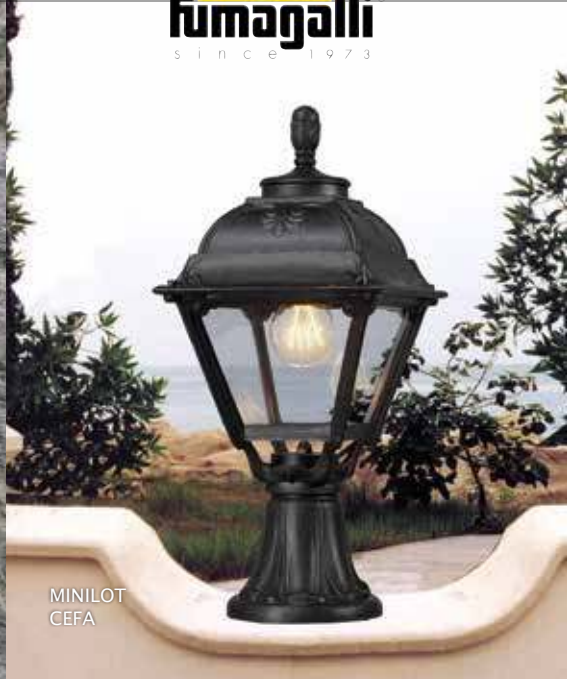

MINILOT
CEFA



RICU
CEFA

CEFA LANTERN	BISSO CEFA	MINILOT CEFA	SICHEM CEFA
<p>BLACK</p> <p>ARTU CEFA</p>			
MIZAR CEFA	ARTU/GIGI CEFA	RICU CEFA	RICU BISSO CEFA 2L/3L

- MAINTENANCE FREE
- ANTI-RUST FINISH
- ANTI-SHOCK BODY
- FULLY RECYCLABLE
- CE EUROPEAN CERTIFIED
- IP55 PROTECTION LEVEL
- UV RAY TREATED
- E27 LAMP BASE
- CLASS II DOUBLE INSULATION

OFFICIAL DISTRIBUTOR

GLOBE 300 RANGE



IAFET
GLOBE 300



GIGI
GLOBE
300



BISSO
GLOBE 300



RICU
BISSO
GLOBE
300 3L



MEDIUM LANTERNS

GLOBE 300 RANGE

GLOBE 300 LANTERN	BISSO G300	MINILOT G300	SICHEM G300
<p>BLACK</p> <p>CLEAR</p> <p>SMOKED</p> <p>OPAL</p>			

IAFET G300	ARTU/GIGI G300	RICU G300	RICU BISSO G300 2L/3L

MAINTENANCE FREE	ANTI-RUST FINISH	ANTI-SHOCK BODY	FULLY RECYCLABLE	EUROPEAN CERTIFIED	PROTECTION LEVEL	UV RAY TREATED	E27 LAMP BASE	CLASS II DOUBLE INSULATION	OFFICIAL DISTRIBUTOR
------------------	------------------	-----------------	------------------	--------------------	------------------	----------------	---------------	----------------------------	--------------------------



LOT NOEMI



SICHEM NOEMI



OFIR NOEMI



ARTU NOEMI

NOEMI LANTERN	OFIR NOEMI	LOT NOEMI	SICHEM NOEMI
BLACK			
E27 HP LED LAMP INCLUDED	A+ RATING		
POWER	30W		
LUMENS	3300Lm		
EFFICIENCY	110Lm/W		
CURRENT	135mA		
POWER FACTOR	>0.9		
BEAM ANGLE	200°		
COLOUR TEMP	4000K		

IAFET NOEMI	ARTU NOEMI	GIGI NOEMI	RICU NOEMI

MAINTENANCE FREE	ANTI-RUST FINISH	ANTI-SHOCK BODY	FULLY RECYCLABLE	EUROPEAN CERTIFIED	PROTECTION LEVEL	UV RAY TREATED	ENERGY SAVING LED	CLASS II DOUBLE INSULATION	OFFICIAL DISTRIBUTOR
------------------	------------------	-----------------	------------------	--------------------	------------------	----------------	-------------------	----------------------------	----------------------



SILOE LANTERN WITH OFIR BRACKET



SILOE LANTERN	OFIR SILOE	LOT SILOE	SICHEM SILOE
BLACK			
E27 HP LED LAMP INCLUDED	A+ RATING		
POWER	30W		
LUMENS	3300Lm		
EFFICIENCY	110Lm/W		
CURRENT	135mA		
POWER FACTOR	>0.9		
BEAM ANGLE	200°		
COLOUR TEMP	4000K		

IAFET SILOE	ARTU SILOE	GIGI SILOE	RICU SILOE

MAINTENANCE FREE	ANTI-RUST FINISH	ANTI-SHOCK BODY	FULLY RECYCLABLE	EUROPEAN CERTIFIED	PROTECTION LEVEL	UV RAY TREATED	ENERGY SAVING LED	CLASS II DOUBLE INSULATION	OFFICIAL DISTRIBUTOR
------------------	------------------	-----------------	------------------	--------------------	------------------	----------------	-------------------	----------------------------	----------------------



GIGI TOBIA



RICU TOBIA









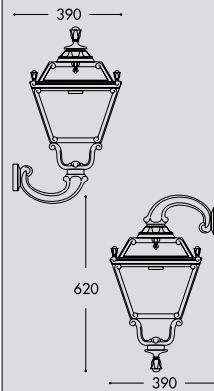
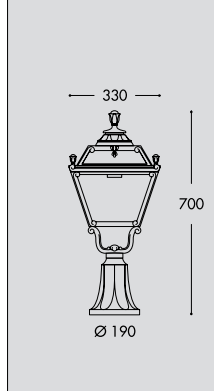
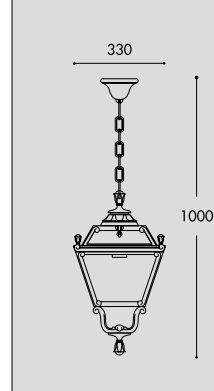

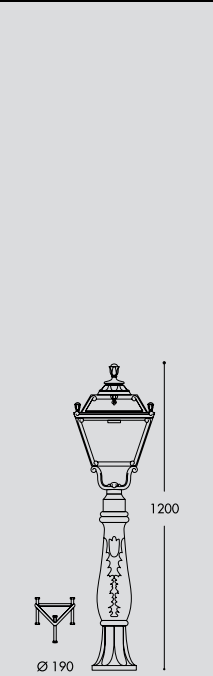
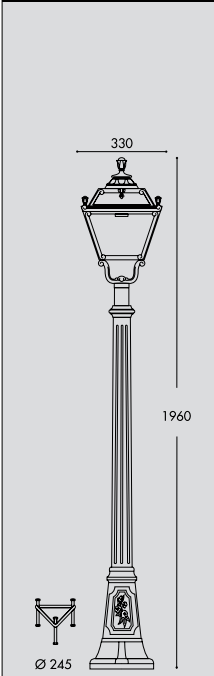
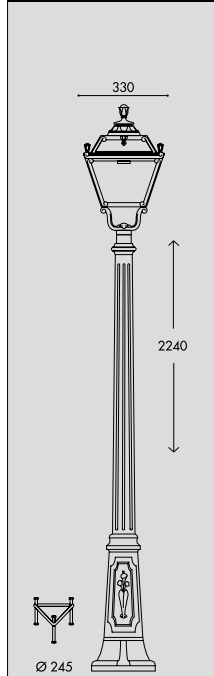
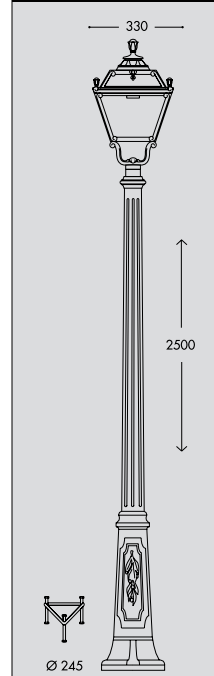

NEBO TOBIA



IAFET TOBIA

TOBIA LANTERN	OFIR TOBIA	LOT TOBIA	SICHEM TOBIA
BLACK 			
E27 HP LED LAMP INCLUDED	A+ RATING		
POWER	30W		
LUMENS	3300Lm		
EFFICIENCY	110Lm/W		
CURRENT	135mA		
POWER FACTOR	>0.9		
BEAM ANGLE	200°		
COLOUR TEMP	4000K		

IAFET TOBIA	ARTU TOBIA	GIGI TOBIA	RICU TOBIA
			

 MAINTENANCE FREE	 ANTI-RUST FINISH	 ANTI-SHOCK BODY	 FULLY RECYCLABLE	 EUROPEAN CERTIFIED	 PROTECTION LEVEL	 UV RAY TREATED	 ENERGY SAVING LED	 CLASS II DOUBLE INSULATION	OFFICIAL DISTRIBUTOR 
--	--	---	--	--	--	--	---	--	--

SIMON LED RANGE



RICU
SIMON



IAFET
SIMON

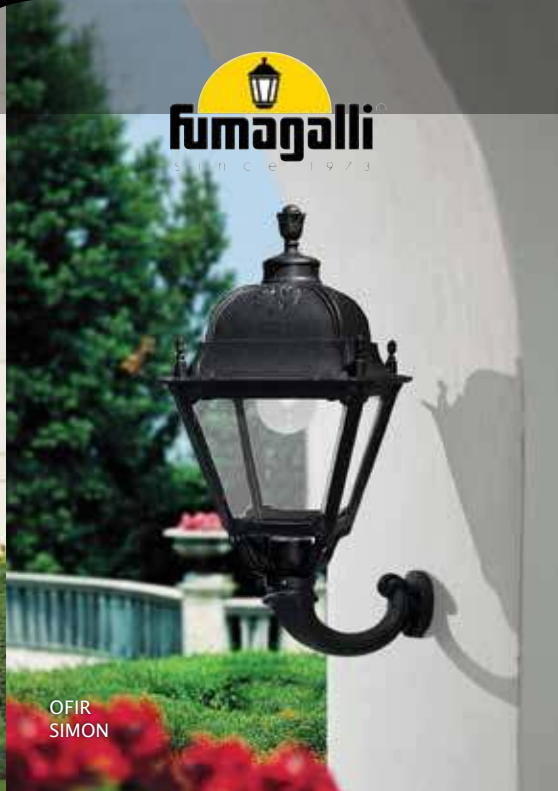

OFIR
SIMON



HOREB
SIMON 3L
WITH ADAM
BRACKET



LARGE LANTERNS

SIMON LED RANGE

SIMON LANTERN	OFIR SIMON	LOT SIMON	SICHEM SIMON
BLACK			
E27 HP LED LAMP INCLUDED	A+ RATING		
POWER	30W		
LUMENS	3300Lm		
EFFICIENCY	110Lm/W		
CURRENT	135mA		
POWER FACTOR	>0.9		
BEAM ANGLE	200°		
COLOUR TEMP	4000K		

IAFET SIMON	ARTU SIMON	GIGI SIMON	RICU SIMON

MAINTENANCE FREE	ANTI-RUST FINISH	ANTI-SHOCK BODY	FULLY RECYCLABLE	EUROPEAN CERTIFIED	PROTECTION LEVEL	UV RAY TREATED	ENERGY SAVING LED	CLASS II DOUBLE INSULATION	OFFICIAL DISTRIBUTOR
------------------	------------------	-----------------	------------------	--------------------	------------------	----------------	-------------------	----------------------------	----------------------



GIONA ELIA 1L



ELIA LANTERN



ELIA LANTERN

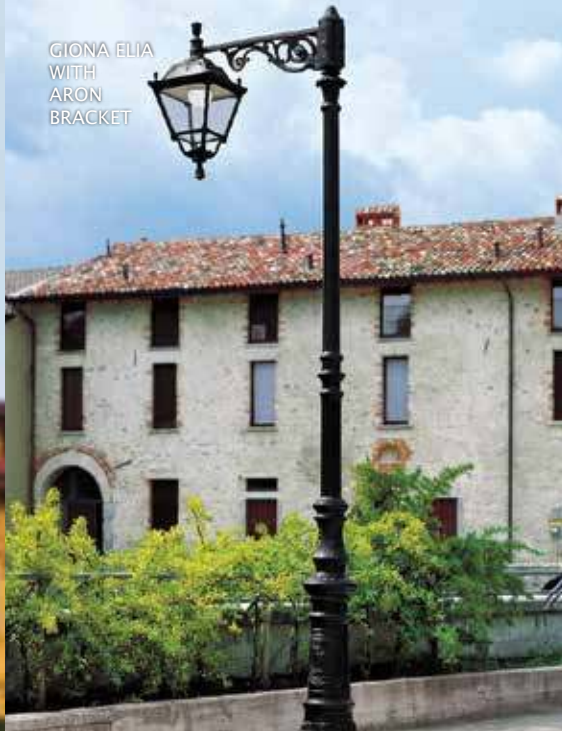

GIONA ELIA WITH ARON BRACKET

ELIA LANTERN	ADAM ELIA	LOT ELIA	SICHEM ELIA
BLACK			
E27 HP LED LAMP INCLUDED	910	910	1150
A+ RATING	660	Ø 190	
POWER 50W			
LUMENS 5000Lm			
EFFICIENCY 100Lm/W			
CURRENT 210mA			
POWER FACTOR >0.9			
BEAM ANGLE 200°			
COLOUR TEMP 4000K			

HOREB ELIA	GIONA ADAM ELIA 2L	GIONA 4500/5000 ELIA	GIONA ADAM ELIA 2+1
430	1500	430	1500
340 4180	4300	4680 5180	4800
Ø 277	400	400	400
	2+1		

MAINTENANCE FREE	ANTI-RUST FINISH	ANTI-SHOCK BODY	FULLY RECYCLABLE	EUROPEAN CERTIFIED	PROTECTION LEVEL	UV RAY TREATED	E27 LAMP BASE	CLASS II DOUBLE INSULATION	OFFICIAL DISTRIBUTOR
------------------	------------------	-----------------	------------------	--------------------	------------------	----------------	---------------	----------------------------	----------------------

GLOBE 400 RANGE



HOREB WITH ADAM BRACKET & GLOBE 400 2+1

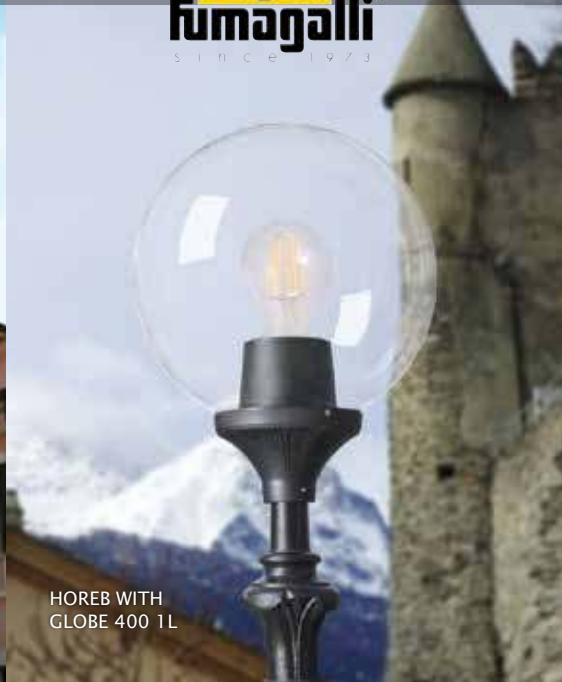

HOREB WITH GLOBE 400 1L



HOREB WITH ADAM BRACKET 2+1 & GLOBE 400



GIONA 4500 WITH ARON BRACKET GLOBE 400*

*GIONA & ARON AVAILABL ONLY ON REQUEST



LARGE LANTERNS

GLOBE 400 RANGE

GLOBE 400 LANTERN	HOREB ADAM G400	LOT G400	SICHEM G400
<p>BLACK</p> <p>CLEAR</p> <p>SMOKED</p> <p>OPAL</p>			
HOREB G400	HOREB ADAM G400 2L	HOREB ADAM G400 3L	HOREB ADAM G400 3L+1

MAINTENANCE FREE	ANTI-RUST FINISH	ANTI-SHOCK BODY	FULLY RECYCLABLE	EUROPEAN CERTIFIED	PROTECTION LEVEL	UV RAY TREATED	E27 LAMP BASE	CLASS II DOUBLE INSULATION
------------------	------------------	-----------------	------------------	--------------------	------------------	----------------	---------------	----------------------------

OFFICIAL DISTRIBUTOR



IESSE HALF LANTERN		DIMENSIONS	SMALL SIZE
BLACK WHITE	REAR VIEW 		

DARIA HALF LANTERN		DIMENSIONS	LARGE SIZE
BLACK	REAR VIEW 		



- MAINTENANCE FREE
- ANTI-RUST FINISH
- ANTI-SHOCK BODY
- FULLY RECYCLABLE
- CE EUROPEAN CERTIFIED
- IP55 PROTECTION LEVEL
- UV RAY TREATED
- E27 LAMP BASE
- CLASS II DOUBLE INSULATION
- OFFICIAL DISTRIBUTOR



SAURO LED	SAURO 500 7W LED	SAURO 800 10W LED	SAURO 1100 10W LED
BLACK	7W LED LAMP INCLUDED A+ RATING	10W LED LAMP INCLUDED A+ RATING	10W LED LAMP INCLUDED A+ RATING
GX53 LED LAMP INCLUDED A+ RATING	800Lm 3000K	1200Lm 3000K	1200Lm 3000K
LAMP	GX53 LED		
POWER	7W	10W	
LUMINOUS FLUX	800 Lm	1200 Lm	
VOLTAGE RANGE	100-240V 50/60Hz		
COLOUR TEMPERATURE	4000K		
INCANDESCENT EQUIVALENT	75W	100W	

SAURO E27	SAURO 500 E27	SAURO 800 E27	SAURO 1100 E27
BLACK	E27 LAMP BASE	E27 LAMP BASE	E27 LAMP BASE
E27 LAMP BASE Suitable for all lamp types including LED			
BODY	SHOCKPROOF RESIN		
DIFFUSER	CLEAR		
PROTECTION	IP55		

MAINTENANCE FREE	ANTI-RUST FINISH	ANTI-SHOCK BODY	FULLY RECYCLABLE	EUROPEAN CERTIFIED	PROTECTION LEVEL	UV RAY TREATED	LED or E27 OPTIONS	CLASS II DOUBLE INSULATION	OFFICIAL DISTRIBUTOR
------------------	------------------	-----------------	------------------	--------------------	------------------	----------------	--------------------	----------------------------	----------------------



ESTER 500
GREY BOLLARD



ESTER GROUND
SPIKE GREY



ESTER 800
BLACK BOLLARD



ESTER WALL
LIGHT BLACK



ESTER 800 BOLLARD GX53 LED LAMP INCLUDED A+ RATING		DIMENSIONS 											
<table border="1"> <tr><td>LAMP</td><td>GX53 LED</td></tr> <tr><td>POWER</td><td>10W</td></tr> <tr><td>LUMINOUS FLUX</td><td>1200Lm</td></tr> <tr><td>VOLTAGE RANGE</td><td>100-240V 50/60Hz</td></tr> <tr><td>COLOUR TEMP</td><td>4000K</td></tr> <tr><td>INCANDESCENT EQUIVALENT</td><td>= 100W</td></tr> </table>				LAMP	GX53 LED	POWER	10W	LUMINOUS FLUX	1200Lm	VOLTAGE RANGE	100-240V 50/60Hz	COLOUR TEMP	4000K
LAMP	GX53 LED												
POWER	10W												
LUMINOUS FLUX	1200Lm												
VOLTAGE RANGE	100-240V 50/60Hz												
COLOUR TEMP	4000K												
INCANDESCENT EQUIVALENT	= 100W												
ESTER 500 BOLLARD GX53 LED LAMP INCLUDED A+ RATING		DIMENSIONS 											
<table border="1"> <tr><td>LAMP</td><td>GX53 LED</td></tr> <tr><td>POWER</td><td>10W</td></tr> <tr><td>LUMINOUS FLUX</td><td>1200Lm</td></tr> <tr><td>VOLTAGE RANGE</td><td>100-240V 50/60Hz</td></tr> <tr><td>COLOUR TEMP</td><td>4000K</td></tr> <tr><td>INCANDESCENT EQUIVALENT</td><td>= 100W</td></tr> </table>				LAMP	GX53 LED	POWER	10W	LUMINOUS FLUX	1200Lm	VOLTAGE RANGE	100-240V 50/60Hz	COLOUR TEMP	4000K
LAMP	GX53 LED												
POWER	10W												
LUMINOUS FLUX	1200Lm												
VOLTAGE RANGE	100-240V 50/60Hz												
COLOUR TEMP	4000K												
INCANDESCENT EQUIVALENT	= 100W												
ESTER SPIKE/WALL GX53 LED LAMP INCLUDED A+ RATING		DIMENSIONS 											
<table border="1"> <tr><td>LAMP</td><td>GX53 LED</td></tr> <tr><td>POWER</td><td>7W</td></tr> <tr><td>LUMINOUS FLUX</td><td>800Lm</td></tr> <tr><td>VOLTAGE RANGE</td><td>100-240V 50/60Hz</td></tr> <tr><td>COLOUR TEMP</td><td>4000K</td></tr> <tr><td>INCANDESCENT EQUIVALENT</td><td>= 75W</td></tr> </table>				LAMP	GX53 LED	POWER	7W	LUMINOUS FLUX	800Lm	VOLTAGE RANGE	100-240V 50/60Hz	COLOUR TEMP	4000K
LAMP	GX53 LED												
POWER	7W												
LUMINOUS FLUX	800Lm												
VOLTAGE RANGE	100-240V 50/60Hz												
COLOUR TEMP	4000K												
INCANDESCENT EQUIVALENT	= 75W												

MAINTENANCE FREE
 ANTI-RUST FINISH
 ANTI-SHOCK BODY

FULLY RECYCLABLE
 EUROPEAN CERTIFIED
 PROTECTION LEVEL

UV RAY TREATED
 ENERGY SAVING LED
 CLASS II DOUBLE INSULATION

OFFICIAL DISTRIBUTOR





ELISA 500
BLACK BOLLARD



ELISA 800
GREY BOLLARD



ELISA WALL
LIGHT GREY



ELISA GROUND
SPIKE BLACK



<p>ELISA 800 BOLLARD</p> <p>BLACK GREY</p> <p>GX53 LED LAMP INCLUDED A+ RATING</p> <table border="1"> <tr><td>LAMP</td><td>GX53 LED</td></tr> <tr><td>POWER</td><td>10W</td></tr> <tr><td>LUMINOUS FLUX</td><td>1200Lm</td></tr> <tr><td>VOLTAGE RANGE</td><td>100-240V 50/60Hz</td></tr> <tr><td>COLOUR TEMP</td><td>4000K</td></tr> <tr><td>INCANDESCENT EQUIVALENT</td><td>= 100W</td></tr> </table>		LAMP	GX53 LED	POWER	10W	LUMINOUS FLUX	1200Lm	VOLTAGE RANGE	100-240V 50/60Hz	COLOUR TEMP	4000K	INCANDESCENT EQUIVALENT	= 100W	<p>DIMENSIONS</p>	
LAMP	GX53 LED														
POWER	10W														
LUMINOUS FLUX	1200Lm														
VOLTAGE RANGE	100-240V 50/60Hz														
COLOUR TEMP	4000K														
INCANDESCENT EQUIVALENT	= 100W														
<p>ELISA 500 BOLLARD</p> <p>BLACK GREY</p> <p>GX53 LED LAMP INCLUDED A+ RATING</p> <table border="1"> <tr><td>LAMP</td><td>GX53 LED</td></tr> <tr><td>POWER</td><td>10W</td></tr> <tr><td>LUMINOUS FLUX</td><td>1200Lm</td></tr> <tr><td>VOLTAGE RANGE</td><td>100-240V 50/60Hz</td></tr> <tr><td>COLOUR TEMP</td><td>4000K</td></tr> <tr><td>INCANDESCENT EQUIVALENT</td><td>= 100W</td></tr> </table>		LAMP	GX53 LED	POWER	10W	LUMINOUS FLUX	1200Lm	VOLTAGE RANGE	100-240V 50/60Hz	COLOUR TEMP	4000K	INCANDESCENT EQUIVALENT	= 100W	<p>DIMENSIONS</p>	
LAMP	GX53 LED														
POWER	10W														
LUMINOUS FLUX	1200Lm														
VOLTAGE RANGE	100-240V 50/60Hz														
COLOUR TEMP	4000K														
INCANDESCENT EQUIVALENT	= 100W														
<p>ELISA SPIKE/WALL</p> <p>BLACK GREY</p> <p>GX53 LED LAMP INCLUDED A+ RATING</p> <table border="1"> <tr><td>LAMP</td><td>GX53 LED</td></tr> <tr><td>POWER</td><td>7W</td></tr> <tr><td>LUMINOUS FLUX</td><td>800Lm</td></tr> <tr><td>VOLTAGE RANGE</td><td>100-240V 50/60Hz</td></tr> <tr><td>COLOUR TEMP</td><td>4000K</td></tr> <tr><td>INCANDESCENT EQUIVALENT</td><td>= 75W</td></tr> </table>		LAMP	GX53 LED	POWER	7W	LUMINOUS FLUX	800Lm	VOLTAGE RANGE	100-240V 50/60Hz	COLOUR TEMP	4000K	INCANDESCENT EQUIVALENT	= 75W	<p>DIMENSIONS</p>	
LAMP	GX53 LED														
POWER	7W														
LUMINOUS FLUX	800Lm														
VOLTAGE RANGE	100-240V 50/60Hz														
COLOUR TEMP	4000K														
INCANDESCENT EQUIVALENT	= 75W														
<p> MAINTENANCE FREE ANTI-RUST FINISH ANTI-SHOCK BODY FULLY RECYCLABLE EUROPEAN CERTIFIED PROTECTION LEVEL UV RAY TREATED ENERGY SAVING LED CLASS II DOUBLE INSULATION </p>															
			<p>OFFICIAL DISTRIBUTOR </p>												

400MM BOLLARD



DIMENSIONS

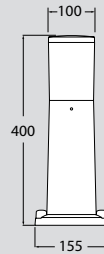

AMELIA 400 BOLLARD



E27 LED LAMP INCLUDED **A+** RATING

LAMP	E27 LED
POWER	12W
LUMINOUS FLUX	1500Lm
VOLTAGE RANGE	100-240V 50/60Hz
COLOUR TEMP	4000K
INCANDESCENT EQUIVALENT	= 100W

GROUND SPIKE



DIMENSIONS

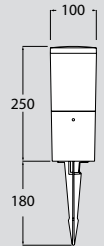

AMELIA SPIKE



E27 LED LAMP INCLUDED **A+** RATING

LAMP	E27 LED
POWER	12w
LUMINOUS FLUX	1500Lm
VOLTAGE RANGE	100-240V 50/60Hz
COLOUR TEMP	4000K
INCANDESCENT EQUIVALENT	= 100W

AMELIA 800 BOLLARD



E27 LED LAMP INCLUDED **A+** RATING

LAMP	E27 LED
POWER	12W
LUMINOUS FLUX	1500Lm
VOLTAGE RANGE	100-240V 50/60Hz
COLOUR TEMP	4000K
INCANDESCENT EQUIVALENT	= 100W

DIMENSIONS

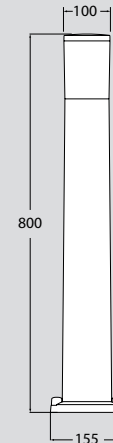

800MM BOLLARD



AMELIA WALL LIGHT



E27 LED LAMP INCLUDED **A+** RATING

LAMP	E27 LED
POWER	8W
LUMINOUS FLUX	1000Lm
VOLTAGE RANGE	100-240V 50/60Hz
COLOUR TEMP	4000K
INCANDESCENT EQUIVALENT	= 75W

DIMENSIONS

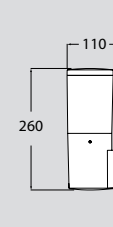

WALL LIGHT



400MM BOLLARD



DIMENSIONS

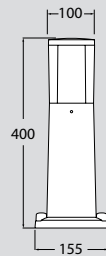

CARLO 400 BOLLARD



GU10 LED LAMP INCLUDED A+ RATING

LAMP	GU10 LED
POWER	3.5W
LUMINOUS FLUX	400Lm
VOLTAGE RANGE	100-240V 50/60Hz
COLOUR TEMP	4000K
HALOGEN EQUIVALENT	= 50W

GROUND SPIKE



DIMENSIONS

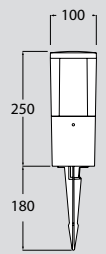

CARLO SPIKE



GU10 LED LAMP INCLUDED A+ RATING

LAMP	GU10 LED
POWER	3.5w
LUMINOUS FLUX	400Lm
VOLTAGE RANGE	100-240V 50/60Hz
COLOUR TEMP	4000K
HALOGEN EQUIVALENT	= 50W

CARLO 800 BOLLARD

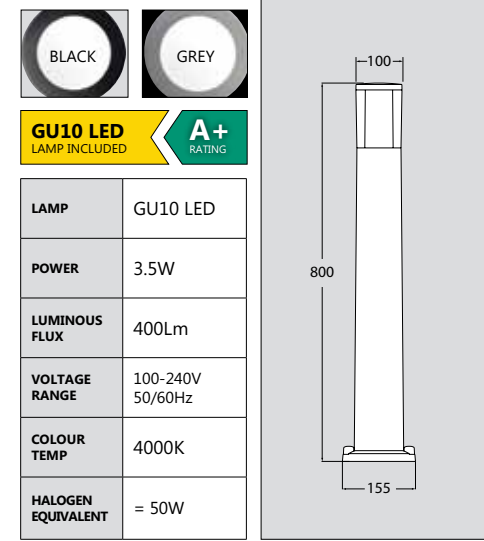

DIMENSIONS

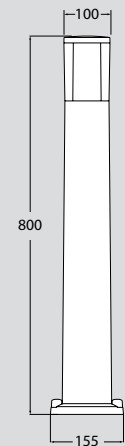

GU10 LED LAMP INCLUDED A+ RATING

LAMP	GU10 LED
POWER	3.5W
LUMINOUS FLUX	400Lm
VOLTAGE RANGE	100-240V 50/60Hz
COLOUR TEMP	4000K
HALOGEN EQUIVALENT	= 50W

800MM BOLLARD



CARLO WALL LIGHT

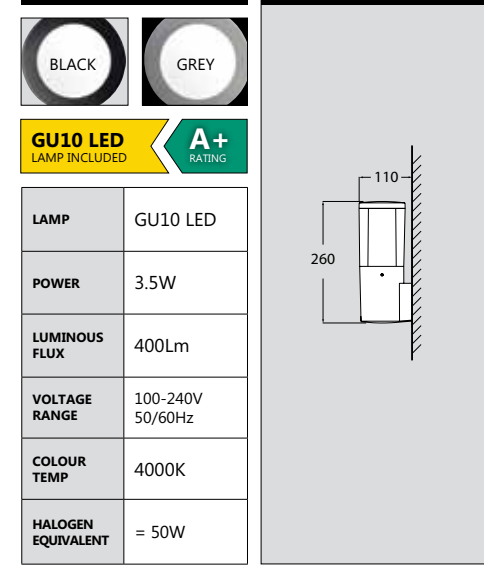

DIMENSIONS

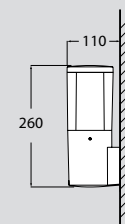

GU10 LED LAMP INCLUDED A+ RATING

LAMP	GU10 LED
POWER	3.5W
LUMINOUS FLUX	400Lm
VOLTAGE RANGE	100-240V 50/60Hz
COLOUR TEMP	4000K
HALOGEN EQUIVALENT	= 50W

WALL LIGHT



*Deco inserts to be ordered separately. Available in black or grey.









FRANCA 90
CEILING
BLACK





FRANCA 90
1L WALL
GREY

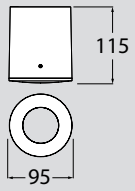





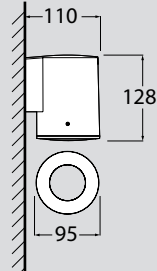





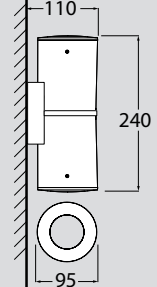



FRANCA 90
2L WALL
GREY



FRANCA 90 CEILING		DIMENSIONS	
			
GU10 LED LAMP INCLUDED		A+ RATING	
LAMP	GU10 LED		
POWER	3.5W		
LUMINOUS FLUX	400lm		
VOLTAGE RANGE	100-240V 50/60Hz		
COLOUR TEMP	4000K		
HALOGEN EQUIVALENT	=50W		

FRANCA 90 1L WALL		DIMENSIONS	
			
GU10 LED LAMP INCLUDED		A+ RATING	
LAMP	GU10 LED		
POWER	3.5W		
LUMINOUS FLUX	400lm		
VOLTAGE RANGE	100-240V 50/60Hz		
COLOUR TEMP	4000K		
HALOGEN EQUIVALENT	=50W		

FRANCA 90 2L WALL		DIMENSIONS	
			
GU10 LED LAMP INCLUDED		A+ RATING	
LAMP	GU10 LED		
POWER	7W (2 x 3.5W)		
LUMINOUS FLUX	800lm		
VOLTAGE RANGE	100-240V 50/60Hz		
COLOUR TEMP	4000K		
HALOGEN EQUIVALENT	=100W		

									OFFICIAL DISTRIBUTOR 
---	---	---	---	---	---	---	---	---	--



ABRAM 150 UP/DOWN

BLACK GREY WHITE

R7s LED LAMP INCLUDED A+ RATING

LAMP	R7s LED
POWER	4W
LUMINOUS FLUX	400lm
VOLTAGE RANGE	100-240V 50/60Hz
COLOUR TEMP	4000K
HALOGEN EQUIVALENT	= 40W

DIMENSIONS

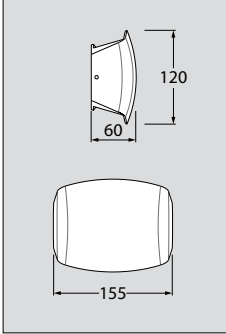

ABRAM 190 UP/DOWN

BLACK GREY WHITE

R7s LED LAMP INCLUDED A+ RATING

LAMP	R7s LED
POWER	8.5W
LUMINOUS FLUX	900lm
VOLTAGE RANGE	100-240V 50/60Hz
COLOUR TEMP	4000K
HALOGEN EQUIVALENT	= 75W

DIMENSIONS

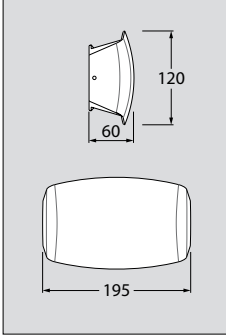

ABRAM 270 UP/DOWN

BLACK GREY WHITE

R7s LED LAMP INCLUDED A+ RATING

LAMP	R7s LED
POWER	11W
LUMINOUS FLUX	1200lm
VOLTAGE RANGE	100-240V 50/60Hz
COLOUR TEMP	4000K
HALOGEN EQUIVALENT	= 100W

DIMENSIONS

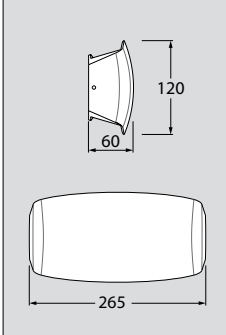

MAINTENANCE FREE	ANTI-RUST FINISH	ANTI-SHOCK BODY	FULLY RECYCLABLE	CE EUROPEAN CERTIFIED	IP55 PROTECTION LEVEL	UV UV RAY TREATED	LED ENERGY SAVING LED	CLASS II DOUBLE INSULATION	OFFICIAL DISTRIBUTOR
------------------	------------------	-----------------	------------------	-----------------------	-----------------------	-------------------	-----------------------	----------------------------	----------------------

MARTA 90 UP/DOWN



MARTA 90
BLACK 2L



MARTA 90
WHITE 2L

MARTA 90
WHITE 1L



MARTA 90
BLACK 1L



LED BULKHEADS

MARTA 90 UP/DOWN

MARTA 90 2L		DIMENSIONS	
GU10 LED LAMP INCLUDED A+ RATING			
LAMP	GU10 LED		
POWER	2 x 4,5W		
LUMINOUS FLUX	600Lm		
VOLTAGE RANGE	100-240V 50/60Hz		
COLOUR TEMPERATURE	4000K		
HALOGEN EQUIVALENT	= 2 X 35W		

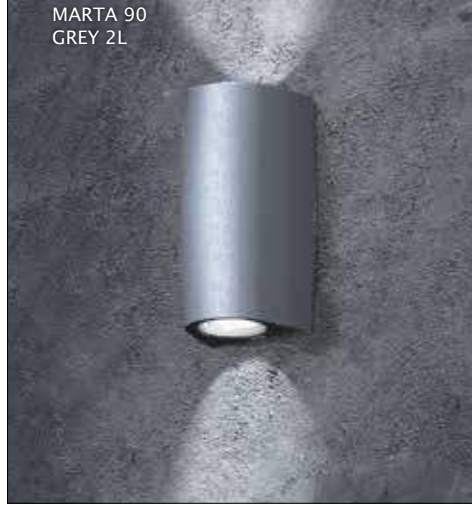

MARTA 90 1L		DIMENSIONS	
GU10 LED LAMP INCLUDED A+ RATING			
LAMP	GU10 LED		
POWER	1 x 4,5W		
LUMINOUS FLUX	300Lm		
VOLTAGE RANGE	100-240V 50/60Hz		
COLOUR TEMPERATURE	4000K		
HALOGEN EQUIVALENT	= 35W		

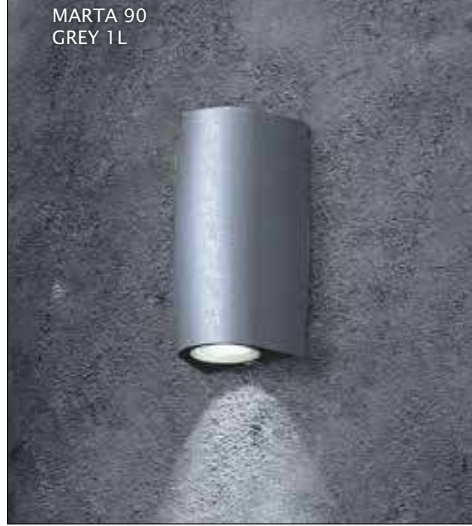

- MAINTENANCE FREE
- ANTI-RUST FINISH
- ANTI-SHOCK BODY
- FULLY RECYCLABLE
- EUROPEAN CERTIFIED
- IP55 PROTECTION LEVEL
- UV RAY TREATED
- LED ENERGY SAVING
- CLASS II DOUBLE INSULATION
- OFFICIAL DISTRIBUTOR
-



MARTA 160 2L

BLACK

GREY

WHITE

GX53 LED
LAMP INCLUDED

A+
RATING

LAMP	GX53 LED
POWER	2 x 10W
LUMINOUS FLUX	2400Lm
VOLTAGE RANGE	100-240V 50/60Hz
COLOUR TEMPERATURE	4000K
HALOGEN EQUIVALENT	= 2 x 100W

DIMENSIONS

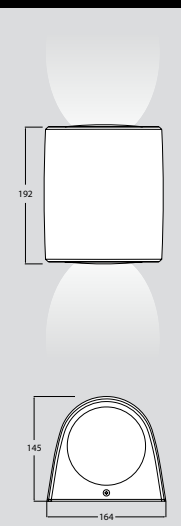



MARTA 160
BLACK 2L

MARTA 160 1L

BLACK

GREY

WHITE

GX53 LED
LAMP INCLUDED

A+
RATING

LAMP	GX53 LED
POWER	1 x 10W
LUMINOUS FLUX	1200Lm
VOLTAGE RANGE	100-240V 50/60Hz
COLOUR TEMPERATURE	4000K
HALOGEN EQUIVALENT	= 100W

DIMENSIONS

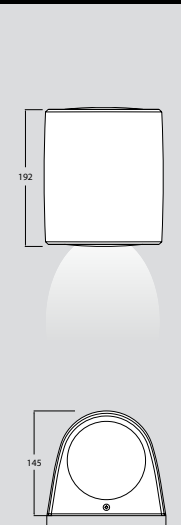



MARTA 160
BLACK 1L

MAINTENANCE FREE

ANTI-RUST FINISH

ANTI-SHOCK BODY

FULLY RECYCLABLE

EUROPEAN CERTIFIED

PROTECTION LEVEL

UV RAY TREATED

ENERGY SAVING LED

CLASS II DOUBLE INSULATION

OFFICIAL DISTRIBUTOR





FRANCY BLACK
UP/DOWN



FRANCY WHITE
UP/DOWN

FRANCY OP
BLACK



FRANCY OP
WHITE



FRANCY E27		DIMENSIONS	
<p>E27 LAMP BASE Suitable for all lamp types including LED</p>			
BODY	SHOCKPROOF RESIN		
DIFFUSER	PMMA		
PROTECTION	IP66		

FRANCY OP LED / E27		DIMENSIONS	
<p>AVAILABLE IN STANDARD E27 OR ENERGY SAVING LED</p>			
<p>GX53 LED LAMP INCLUDED IN 2 x 3W MODELS</p>			
LAMP	GX53 LED		
POWER	2 x 3W		
LUMINOUS FLUX	700Lm		
VOLTAGE RANGE	100-240V 50/60Hz		
COLOUR TEMPERATURE	4000K		
INCANDESCENT EQUIVALENT	= 60W		

									OFFICIAL DISTRIBUTOR
MAINTENANCE FREE	ANTI-RUST FINISH	ANTI-SHOCK BODY	FULLY RECYCLABLE	EUROPEAN CERTIFIED	PROTECTION LEVEL	UV RAY TREATED	LED or E27 OPTIONS	DOUBLE INSULATION	



MINITOMMY
GROUND SPIKE

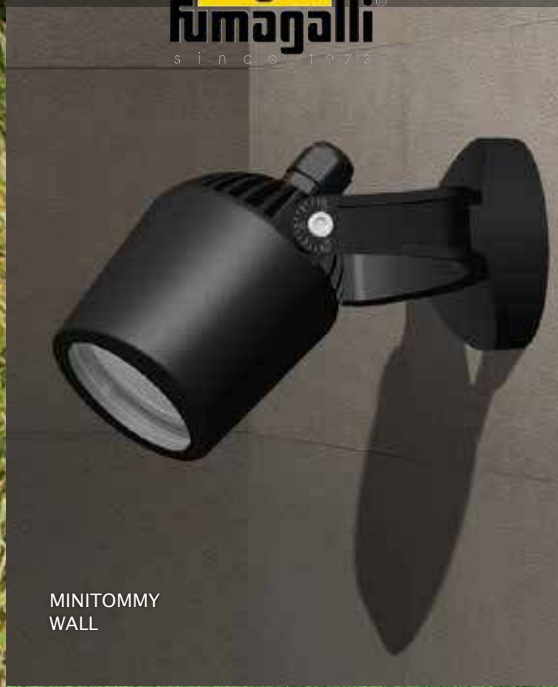

MINITOMMY
WALL



TOMMY
WALL



TOMMY
GROUND SPIKE



MINITOMMY LED



BLACK

GU10 LED
LAMP INCLUDED

A+
RATING

LAMP	GU10 LED
POWER	4.5W
LUMINOUS FLUX	300Lm
VOLTAGE RANGE	100-240V 50/60Hz
COLOUR TEMP	4000K
HALOGEN EQUIVALENT	= 35W

DIMENSIONS

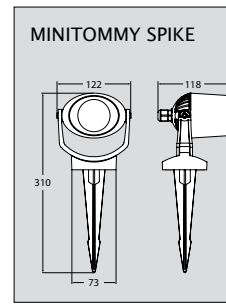
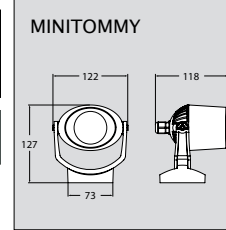

TOMMY LED



BLACK

GX53 LED
LAMP INCLUDED

A+
RATING

LAMP	GX53 LED	
POWER	7W	10W
LUMINOUS FLUX	800Lm	1200Lm
VOLTAGE RANGE	100-240V 50/60Hz	
COLOUR TEMP	4000K	
INCANDESCENT EQUIVALENT	75W	100W

DIMENSIONS

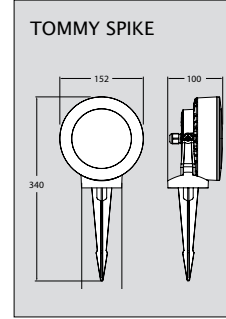
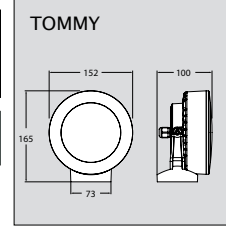

- MAINTENANCE FREE
- ANTI-RUST FINISH
- ANTI-SHOCK BODY
- FULLY RECYCLABLE
- EUROPEAN CERTIFIED
- IP66 PROTECTION LEVEL
- UV RAY TREATED
- LED ENERGY SAVING LED
- CLASS II DOUBLE INSULATION
- OFFICIAL DISTRIBUTOR
-



GIUSEPPE BLACK WITH GIOVA BRACKET



GERMANA BLACK WITH GIOVA BRACKET



MINIPINELA 1L BLACK



PINELA 1L BLACK



GIOVA GERMANA	
AVAILABLE IN E27 OR LED	
GX53 LED <small>LAMPS INCLUDED IN 20W LED MODELS</small>	
A+ RATING	
LAMP	GX53 LED
POWER	2 x 10W
LUMINOUS FLUX	2400Lm
VOLTAGE	100-240V 50/60Hz
COLOUR TEMP	4000K

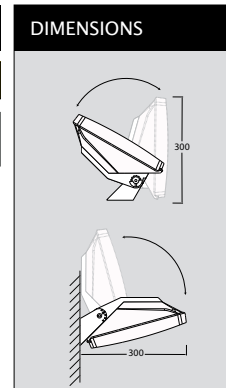

GIOVA GIUSEPPE	
AVAILABLE IN E27 OR LED	
GX53 LED <small>LAMPS INCLUDED IN 20W LED MODELS</small>	
A+ RATING	
LAMP	GX53 LED
POWER	4 x 10W
LUMINOUS FLUX	4800Lm
VOLTAGE	100-240V 50/60Hz
COLOUR TEMP	4000K

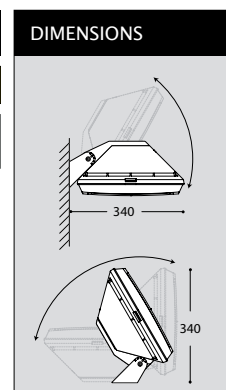

PINELA/MINIPINELA 1L	
BLACK GREY	AVAILABLE IN E27 OR LED
GX53 LED <small>LAMPS INCLUDED IN PINELA & MINIPINELA 20W LED MODELS</small>	
A+ RATING	
LAMP	GX53 LED
POWER	2 x 10W
LUMINOUS FLUX	2400Lm
VOLTAGE	100-240V 50/60Hz
COLOUR TEMP	4000K

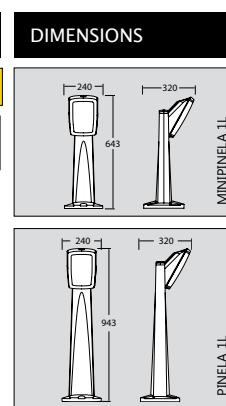

									OFFICIAL DISTRIBUTOR
--	--	--	--	--	--	--	--	--	----------------------

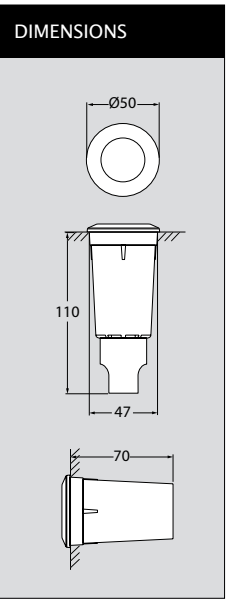

ALDO ROUND

BLACK

G9 LED
LAMPS INCLUDED **A+**
RATING

LAMP	G9 LED
POWER	1.7W
LUMINOUS FLUX	170Lm
VOLTAGE RANGE	100-240V 50/60Hz
COLOUR TEMP	4000K
INCANDESCENT EQUIVALENT	= 15W

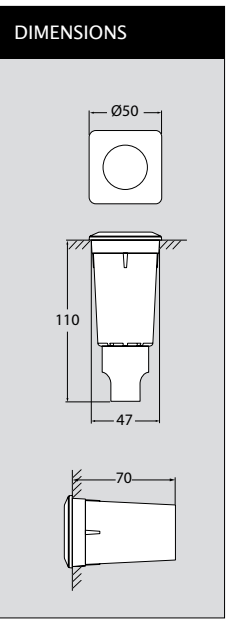

ALDO SQUARE

BLACK

G9 LED
LAMPS INCLUDED **A+**
RATING

LAMP	G9 LED
POWER	1.7W
LUMINOUS FLUX	170Lm
VOLTAGE RANGE	100-240V 50/60Hz
COLOUR TEMP	4000K
HALOGEN EQUIVALENT	= 15W



- CLASS II
- LED
- UV RAY TREATED
- PROTECTION LEVEL
- EUROPEAN CERTIFIED
- FULLY RECYCLABLE
- ANTI-SHOCK BODY
- ANTI-RUST FINISH
- MAINTENANCE FREE

CECI 90 LED

BLACK

GU10 LED
LAMP INCLUDED **A+**
RATING

LAMP	GU10 LED
POWER	4.5W
LUMINOUS FLUX	300Lm
VOLTAGE RANGE	100-240V 50/60Hz
COLOUR TEMP	4000K
HALOGEN EQUIVALENT	= 35W

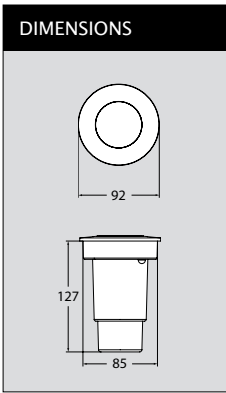

CECI 90 2L LED

BLACK

GU10 LED
LAMP INCLUDED **A+**
RATING

LAMP	GU10 LED
POWER	4.5W
LUMINOUS FLUX	300Lm
VOLTAGE RANGE	100-240V 50/60Hz
COLOUR TEMP	4000K
HALOGEN EQUIVALENT	= 35W

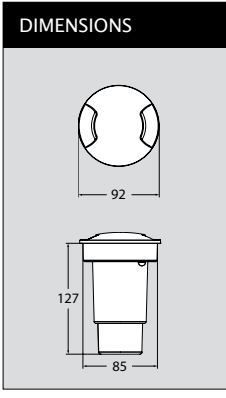

CECI 90 3L LED

BLACK

GU10 LED
LAMP INCLUDED **A+**
RATING

LAMP	GU10 LED
POWER	4.5W
LUMINOUS FLUX	300Lm
VOLTAGE RANGE	100-240V 50/60Hz
COLOUR TEMP	4000K
HALOGEN EQUIVALENT	= 35W

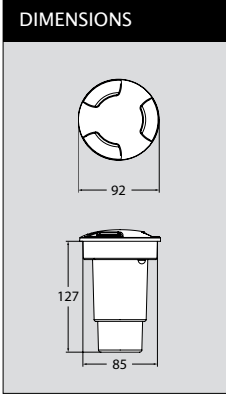

- MAINTENANCE FREE
- ANTI-RUST FINISH
- ANTI-SHOCK BODY
- FULLY RECYCLABLE
- EUROPEAN CERTIFIED
- PROTECTION LEVEL
- UV RAY TREATED
- ENERGY SAVING LED
- CLASS II





DIMENSIONS

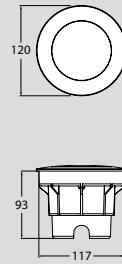

CECI 120 LED

BLACK

GX53 LED
LAMP INCLUDED **A+** RATING

LAMP	GX53 LED
POWER	3W
LUMINOUS FLUX	350lm
VOLTAGE RANGE	100-240V 50/60Hz
COLOUR TEMP	4000K
INCANDESCENT EQUIVALENT	= 40W



DIMENSIONS

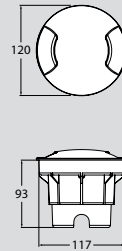

CECI 120 2L LED

BLACK

GX53 LED
LAMP INCLUDED **A+** RATING

LAMP	GX53 LED
POWER	3W
LUMINOUS FLUX	350lm
VOLTAGE RANGE	100-240V 50/60Hz
COLOUR TEMP	4000K
INCANDESCENT EQUIVALENT	= 40W

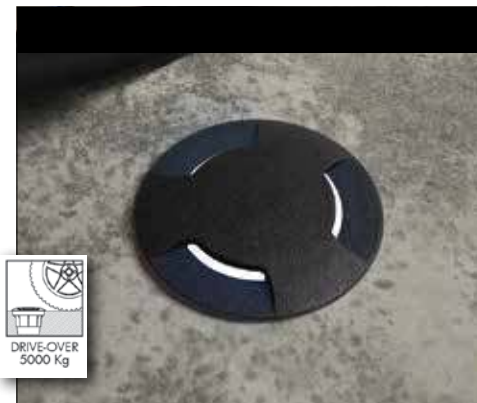

DIMENSIONS

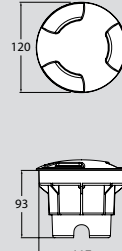

CECI 120 3L LED

BLACK

GX53 LED
LAMP INCLUDED **A+** RATING

LAMP	GX53 LED
POWER	3W
LUMINOUS FLUX	350lm
VOLTAGE RANGE	100-240V 50/60Hz
COLOUR TEMP	4000K
INCANDESCENT EQUIVALENT	= 40W

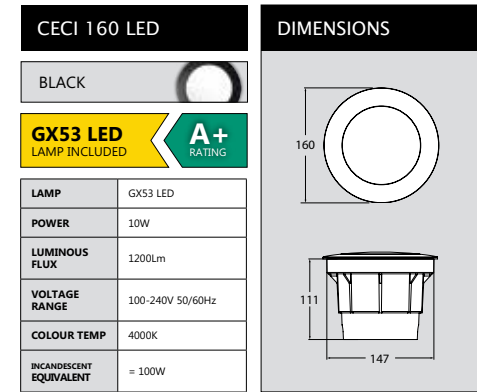

DIMENSIONS

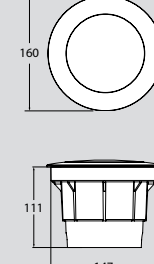

CECI 160 LED

BLACK

GX53 LED
LAMP INCLUDED **A+** RATING

LAMP	GX53 LED
POWER	10W
LUMINOUS FLUX	1200lm
VOLTAGE RANGE	100-240V 50/60Hz
COLOUR TEMP	4000K
INCANDESCENT EQUIVALENT	= 100W

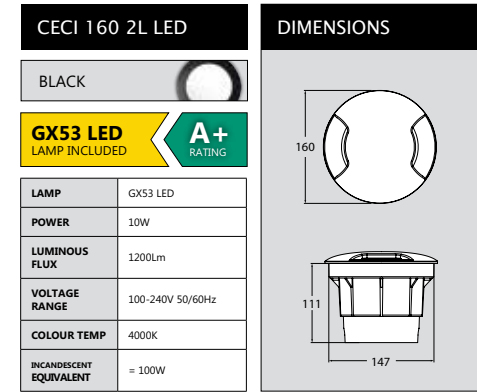

DIMENSIONS

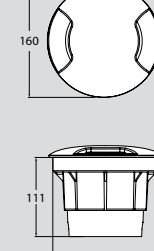

CECI 160 2L LED

BLACK

GX53 LED
LAMP INCLUDED **A+** RATING

LAMP	GX53 LED
POWER	10W
LUMINOUS FLUX	1200lm
VOLTAGE RANGE	100-240V 50/60Hz
COLOUR TEMP	4000K
INCANDESCENT EQUIVALENT	= 100W

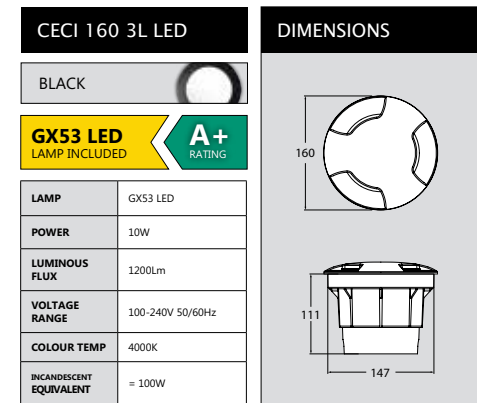

DIMENSIONS

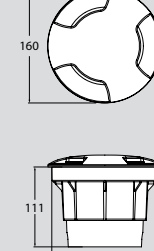

CECI 160 3L LED

BLACK

GX53 LED
LAMP INCLUDED **A+** RATING

LAMP	GX53 LED
POWER	10W
LUMINOUS FLUX	1200lm
VOLTAGE RANGE	100-240V 50/60Hz
COLOUR TEMP	4000K
INCANDESCENT EQUIVALENT	= 100W



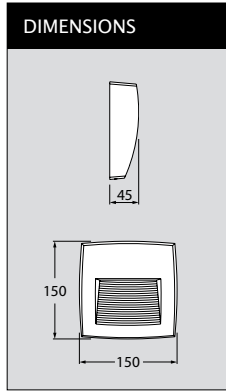

LORENZA 150 LED

BLACK GREY WHITE

R7s LED
LAMP INCLUDED

A+
RATING

LAMP	R7s LED
POWER	4W
LUMINOUS FLUX	400lm
VOLTAGE RANGE	100-240V 50/60Hz
COLOUR TEMP	4000K
INCANDESCENT EQUIVALENT	= 40W

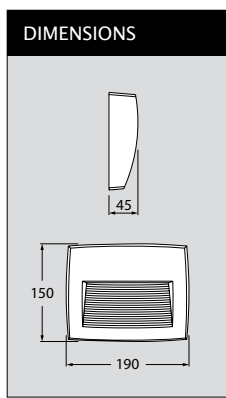

LORENZA 190 LED

BLACK GREY WHITE

R7s LED
LAMP INCLUDED

A+
RATING

LAMP	R7s LED
POWER	8.5W
LUMINOUS FLUX	900lm
VOLTAGE RANGE	100-240V 50/60Hz
COLOUR TEMP	4000K
INCANDESCENT EQUIVALENT	= 75W

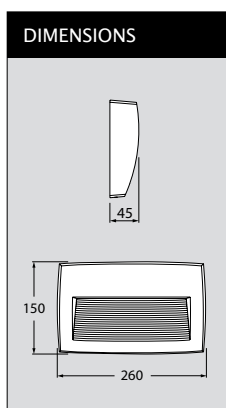

LORENZA 270 LED

BLACK GREY WHITE

R7s LED
LAMP INCLUDED

A+
RATING

LAMP	R7s LED
POWER	11W
LUMINOUS FLUX	1200lm
VOLTAGE RANGE	100-240V 50/60Hz
COLOUR TEMP	4000K
INCANDESCENT EQUIVALENT	= 100W



NINA 150 LED

BLACK GREY WHITE

R7s LED
LAMP INCLUDED

A+
RATING

LAMP	R7s LED
POWER	4W
LUMINOUS FLUX	400lm
VOLTAGE RANGE	100-240V 50/60Hz
COLOUR TEMP	4000K
HALOGEN EQUIVALENT	= 35W

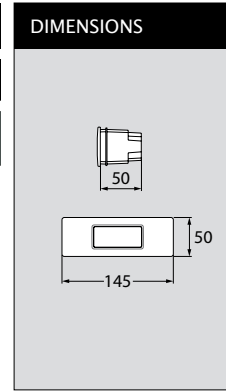

NINA 190 LED

BLACK GREY WHITE

R7s LED
LAMP INCLUDED

A+
RATING

LAMP	R7s LED
POWER	8.5W
LUMINOUS FLUX	900lm
VOLTAGE RANGE	100-240V 50/60Hz
COLOUR TEMP	4000K
HALOGEN EQUIVALENT	= 50W

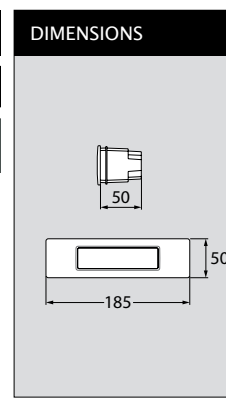

NINA 270 LED

BLACK GREY WHITE

R7s LED
LAMP INCLUDED

A+
RATING

LAMP	R7s LED
POWER	11W
LUMINOUS FLUX	1200lm
VOLTAGE RANGE	100-240V 50/60Hz
COLOUR TEMP	4000K
HALOGEN EQUIVALENT	= 75W

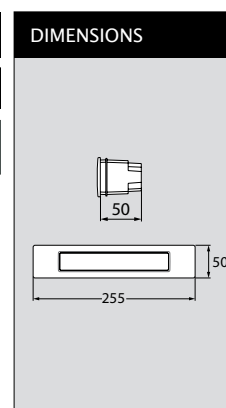

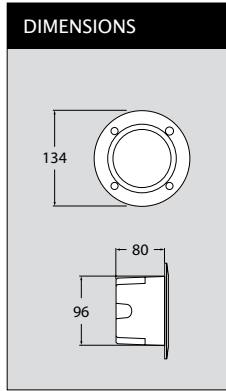

LETI 100 LED

BLACK

GX53 LED
LAMP INCLUDED **A+**
RATING

LAMP	GX53 LED
POWER	3W
LUMINOUS FLUX	350lm
VOLTAGE RANGE	100-240V 50/60Hz
COLOUR TEMP	4000K
INCANDESCENT EQUIVALENT	= 40W

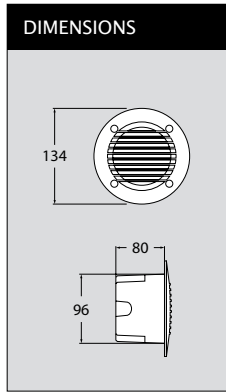

LETI 100 GRILLE LED

BLACK

GX53 LED
LAMP INCLUDED **A+**
RATING

LAMP	GX53 LED
POWER	3W
LUMINOUS FLUX	350lm
VOLTAGE RANGE	100-240V 50/60Hz
COLOUR TEMP	4000K
INCANDESCENT EQUIVALENT	= 40W

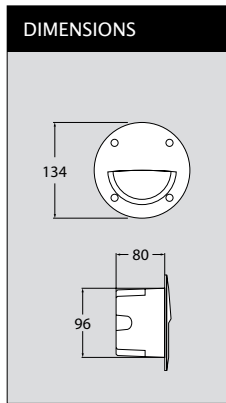

LETI 100 EYELID LED

BLACK

GX53 LED
LAMP INCLUDED **A+**
RATING

LAMP	GX53 LED
POWER	3W
LUMINOUS FLUX	350lm
VOLTAGE RANGE	100-240V 50/60Hz
COLOUR TEMP	4000K
INCANDESCENT EQUIVALENT	= 40W



LETI 100 SQ LED

BLACK

GX53 LED
LAMP INCLUDED **A+**
RATING

LAMP	GX53 LED
POWER	3W
LUMINOUS FLUX	350lm
VOLTAGE RANGE	100-240V 50/60Hz
COLOUR TEMP	4000K
INCANDESCENT EQUIVALENT	= 40W

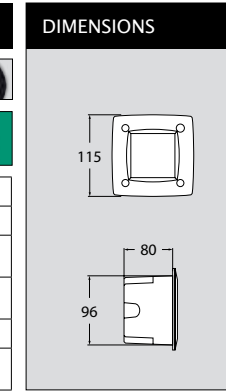

LETI 100 SQ GRILLE LED

BLACK

GX53 LED
LAMP INCLUDED **A+**
RATING

LAMP	GX53 LED
POWER	3W
LUMINOUS FLUX	350lm
VOLTAGE RANGE	100-240V 50/60Hz
COLOUR TEMP	4000K
INCANDESCENT EQUIVALENT	= 40W

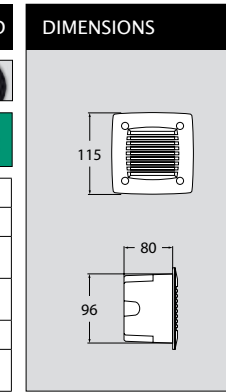

LETI 100 SQ EYELID LED

BLACK

GX53 LED
LAMP INCLUDED **A+**
RATING

LAMP	GX53 LED
POWER	3W
LUMINOUS FLUX	350lm
VOLTAGE RANGE	100-240V 50/60Hz
COLOUR TEMP	4000K
INCANDESCENT EQUIVALENT	= 40W

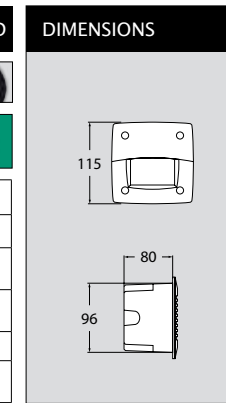

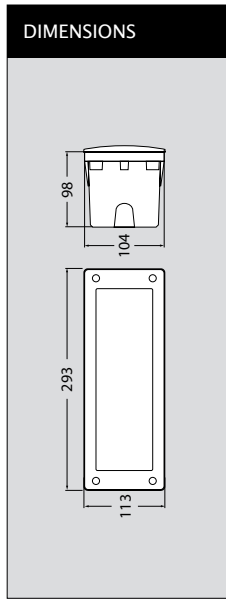

LETI 300 PLAIN

BLACK 

GX53 LED
LAMPS INCLUDED **A+**
RATING

LAMP	GX53 LED
POWER	6W (2x3W)
LUMINOUS FLUX	700Lm
VOLTAGE RANGE	100-240V 50/60Hz
COLOUR TEMP	4000K
INCANDESCENT EQUIVALENT	= 60W

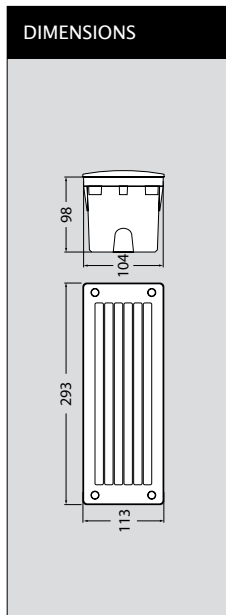

LETI 300 GRILLE

BLACK 

GX53 LED
LAMPS INCLUDED **A+**
RATING

LAMP	GX53 LED
POWER	6w (2x3W)
LUMINOUS FLUX	700Lm
VOLTAGE RANGE	100-240V 50/60Hz
COLOUR TEMP	4000K
INCANDESCENT EQUIVALENT	= 60W

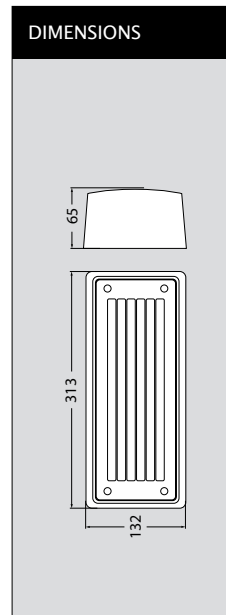
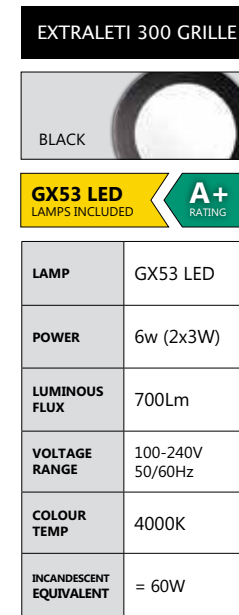
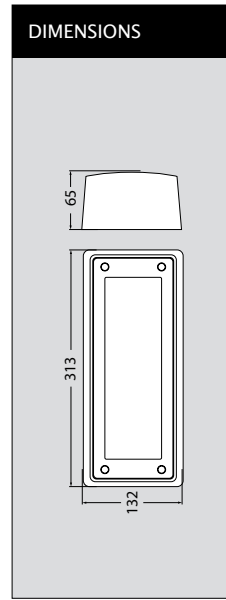
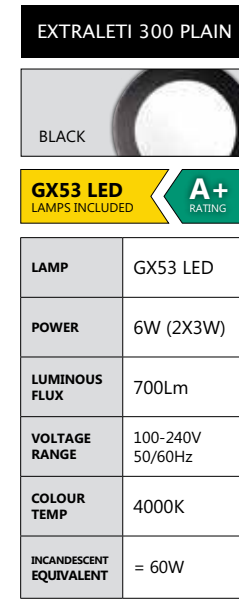



BERTINA SMALL LED BULKHEAD

BERTA MEDIUM LED BULKHEAD











BERTINA LED		DIMENSIONS	SMALL SIZE
GX53 LED LAMP INCLUDED A+ RATING			
LAMP	GX53 LED		
POWER	7W		
LUMINOUS FLUX	800Lm		
VOLTAGE RANGE	100-240V 50/60Hz		
COLOUR TEMP	4000K		
INCANDESCENT EQUIVALENT	= 75W		

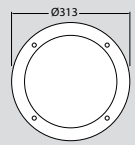

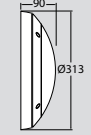

BERTA LED		DIMENSIONS	MEDIUM SIZE
GX53 LED LAMP INCLUDED A+ RATING			
LAMP	GX53 LED		
POWER	11W		
LUMINOUS FLUX	1300Lm		
VOLTAGE RANGE	100-240V 50/60Hz		
COLOUR TEMP	4000K		
INCANDESCENT EQUIVALENT	= 100W		

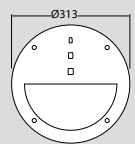

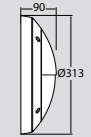



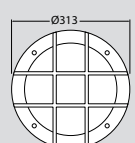

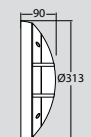

- MAINTENANCE FREE
- ANTI-RUST FINISH
- ANTI-SHOCK BODY
- FULLY RECYCLABLE
- EUROPEAN CERTIFIED
- IP66 PROTECTION LEVEL
- UV RAY TREATED
- LED ENERGY SAVING LED
- CLASS II DOUBLE INSULATION
- OFFICIAL DISTRIBUTOR











GELMI E27		DIMENSIONS		
BLACK 				
E27 LAMP BASE Suitable for all lamp types including LED 				
BODY	SHOCKPROOF RESIN			
DIFFUSER	OPAL			
PROTECTION	IP66			

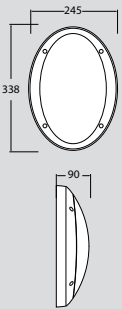



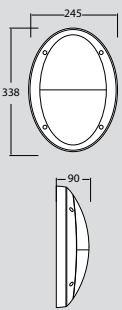

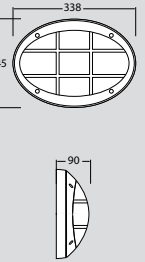



GELMI EYELID E27		DIMENSIONS		
BLACK 				
E27 LAMP BASE Suitable for all lamp types including LED 				
BODY	SHOCKPROOF RESIN			
DIFFUSER	OPAL			
PROTECTION	IP66			

GELMI GRILLE E27		DIMENSIONS		
BLACK 				
E27 LAMP BASE Suitable for all lamp types including LED 				
BODY	SHOCKPROOF RESIN			
DIFFUSER	OPAL			
PROTECTION	IP66			





 MAINTENANCE FREE	 ANTI-RUST FINISH	 ANTI-SHOCK BODY	 FULLY RECYCLABLE	 CE EUROPEAN CERTIFIED	 IP66 PROTECTION LEVEL	 UV RAY TREATED	 E27 LAMP BASE	 CLASS II DOUBLE INSULATION	OFFICIAL DISTRIBUTOR 
--	--	---	--	---	---	--	---	--	--





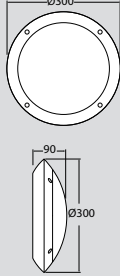

<p>DANZI E27</p> <p>BLACK </p> <p>E27 LAMP BASE Suitable for all lamp types including LED </p> <table border="1"> <tr> <td>BODY</td> <td>SHOCKPROOF RESIN</td> </tr> <tr> <td>DIFFUSER</td> <td>OPAL</td> </tr> <tr> <td>PROTECTION</td> <td>IP66</td> </tr> </table>	BODY	SHOCKPROOF RESIN	DIFFUSER	OPAL	PROTECTION	IP66	<p>DIMENSIONS</p> 	
BODY	SHOCKPROOF RESIN							
DIFFUSER	OPAL							
PROTECTION	IP66							
<p>DANZI EYELID E27</p> <p>BLACK </p> <p>E27 LAMP BASE Suitable for all lamp types including LED </p> <table border="1"> <tr> <td>BODY</td> <td>SHOCKPROOF RESIN</td> </tr> <tr> <td>DIFFUSER</td> <td>OPAL</td> </tr> <tr> <td>PROTECTION</td> <td>IP66</td> </tr> </table>	BODY	SHOCKPROOF RESIN	DIFFUSER	OPAL	PROTECTION	IP66	<p>DIMENSIONS</p> 	
BODY	SHOCKPROOF RESIN							
DIFFUSER	OPAL							
PROTECTION	IP66							
<p>DANZI GRILLE E27</p> <p>BLACK </p> <p>E27 LAMP BASE Suitable for all lamp types including LED </p> <table border="1"> <tr> <td>BODY</td> <td>SHOCKPROOF RESIN</td> </tr> <tr> <td>DIFFUSER</td> <td>OPAL</td> </tr> <tr> <td>PROTECTION</td> <td>IP66</td> </tr> </table>	BODY	SHOCKPROOF RESIN	DIFFUSER	OPAL	PROTECTION	IP66	<p>DIMENSIONS</p> 	
BODY	SHOCKPROOF RESIN							
DIFFUSER	OPAL							
PROTECTION	IP66							

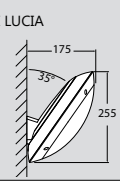



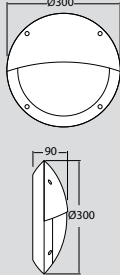

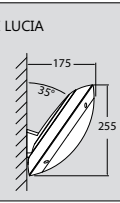



									OFFICIAL DISTRIBUTOR 
---	---	---	---	---	---	---	---	---	--



LUCIA PLAIN E27		DIMENSIONS		
 BLACK		LUCIA PLAIN		
 E27 LAMP BASE Suitable for all lamp types including LED				
BODY	SHOCKPROOF RESIN			
DIFFUSER	OPAL			
PROTECTION	IP66			
 REMI BRACKET WITH LUCIA		REMI LUCIA		
				

LUCIA EYELID E27		DIMENSIONS		
 BLACK		LUCIA EYELID		
 E27 LAMP BASE Suitable for all lamp types including LED				
BODY	SHOCKPROOF RESIN			
DIFFUSER	OPAL			
PROTECTION	IP66			
 REMI BRACKET WITH LUCIA EYELID		REMI LUCIA		
				



 MAINTENANCE FREE	 ANTI-RUST FINISH	 ANTI-SHOCK BODY	 FULLY RECYCLABLE	 CE EUROPEAN CERTIFIED	 IP66 PROTECTION LEVEL	 UV RAY TREATED	 E27 LAMP BASE	 CLASS II DOUBLE INSULATION	OFFICIAL DISTRIBUTOR 
--	--	---	--	---	---	--	---	--	--



MADDI PLAIN E27		DIMENSIONS		
BLACK		MADDI PLAIN 		
E27 LAMP BASE Suitable for all lamp types including LED				
BODY	SHOCKPROOF RESIN	DIFFUSER	OPAL	
PROTECTION	IP66			
REMI BRACKET WITH MADDI		REMI MADDI 		

MADDI EYELID E27		DIMENSIONS		
BLACK		MADDI EYELID 		
E27 LAMP BASE Suitable for all lamp types including LED				
BODY	SHOCKPROOF RESIN	DIFFUSER	OPAL	
PROTECTION	IP66			
REMI BRACKET WITH MADDI EYELID		REMI MADDI 		

MAINTENANCE FREE	ANTI-RUST FINISH	ANTI-SHOCK BODY	FULLY RECYCLABLE	EUROPEAN CERTIFIED	PROTECTION LEVEL	UV RAY TREATED	E27 LAMP BASE	CLASS II DOUBLE INSULATION	OFFICIAL DISTRIBUTOR
------------------	------------------	-----------------	------------------	--------------------	------------------	----------------	---------------	----------------------------	----------------------



GABRI WITH REMI BRACKET & LUCIA EYELID 2L











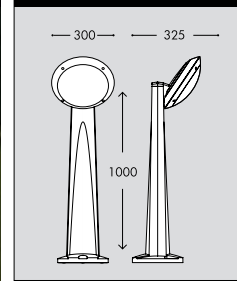

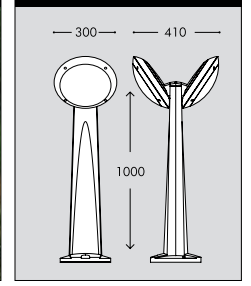

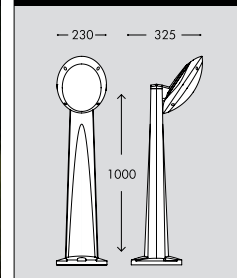

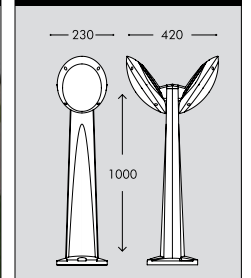

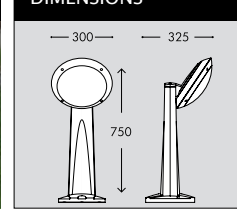

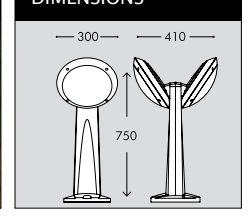

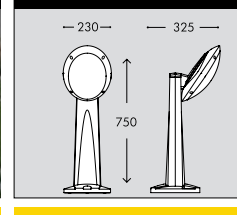

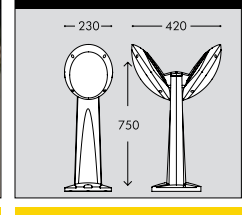
GABRI WITH REMI BRACKET & LUCIA 1L

MINIGABRI WITH REMI BRACKET & MADDI 2L

MINIGABRI WITH REMI BRACKET & LUCIA EYELID 1L

PINELA & MINIPINELA 1L
SEE PAGE 53

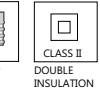

<p>GABRI REMI LUCIA 1L</p> 	<p>DIMENSIONS</p> 	<p>GABRI REMI LUCIA 2L</p> 	<p>DIMENSIONS</p> 						
<p>GABRI REMI MADDI 1L</p> 	<p>DIMENSIONS</p> 	<p>GABRI REMI MADDI 2L</p> 	<p>DIMENSIONS</p> 						
<p>MINIGABRI REMI LUCIA 1L</p> 	<p>DIMENSIONS</p> 	<p>MINIGABRI REMI LUCIA 2L</p> 	<p>DIMENSIONS</p> 						
<p>MINIGABRI REMI MADDI 1L</p> 	<p>DIMENSIONS</p> 	<p>MINIGABRI REMI MADDI 2L</p> 	<p>DIMENSIONS</p> 						
 <p>MAINTENANCE FREE</p>	 <p>ANTI-RUST FINISH</p>	 <p>ANTI-SHOCK BODY</p>	 <p>FULLY RECYCLABLE</p>	 <p>EUROPEAN CERTIFIED</p>	 <p>IP66 PROTECTION LEVEL</p>	 <p>UV RAY TREATED</p>	 <p>E27 LAMP BASE</p>	 <p>CLASS II DOUBLE INSULATION</p>	<p>OFFICIAL DISTRIBUTOR</p> 

BEPPE 400
HIGH POWER LED



50W 5300Lm
TUV CERTIFIED
LED LAMP



GINO 400
HP LED BLACK



GINO 400
HP LED GREY



BEPPE 400 LED		DIMENSIONS	HIGH POWER LED LIGHTING
<p>HP E27 LED LAMP INCLUDED</p> <p>A+ RATING</p>			
LAMP	HIGH-POWER E27 LED		
POWER	50W		
LUMINOUS FLUX	5300Lm		
VOLTAGE RANGE	100-240V 50/60Hz		
COLOUR TEMP	4000K		
HQI/SON EQUIVALENT	= 115W		

GINO 400 HP LED		DIMENSIONS	GINO 400 HP LED WITH EKTOR POLE NEW!
<p>HP E27 LED LAMP INCLUDED</p> <p>A+ RATING</p>			
LAMP	HIGH-POWER E27 LED		
POWER	50W		
LUMINOUS FLUX	5300Lm		
VOLTAGE RANGE	100-240V 50/60Hz		
COLOUR TEMP	4000K		
HQI/SON EQUIVALENT	= 115W		

MAINTENANCE FREE	ANTI-RUST FINISH	ANTI-SHOCK BODY	FULLY RECYCLABLE	EUROPEAN CERTIFIED	PROTECTION LEVEL	UV RAY TREATED	LED or E27 OPTIONS	CLASS II DOUBLE INSULATION	OFFICIAL DISTRIBUTOR
------------------	------------------	-----------------	------------------	--------------------	------------------	----------------	--------------------	----------------------------	----------------------

CLASSIC POLES UP TO 2000MM

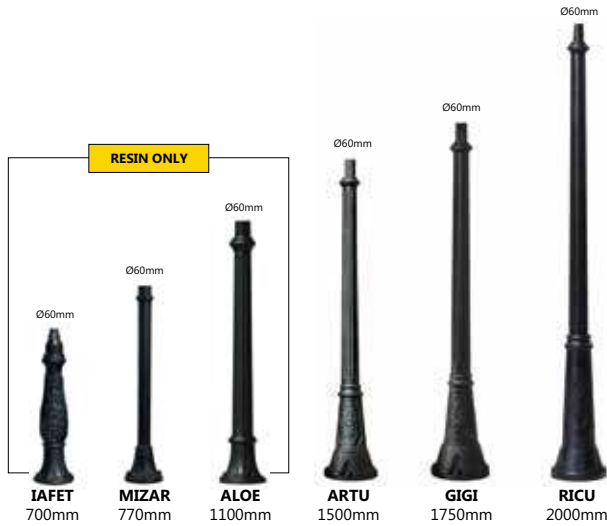

FEATURES



Ø60MM	THE STANDARDISED Ø60MM CONNECTION HUB IS COMPATIBLE WITH ALL FUMAGALLI LANTERNS/BRACKETS
MATERIAL	FUMATECH® STEEL, EXPANSE & RESIN* *EXCEPT WHERE OTHERWISE STATED
FINISH	MAINTENANCE FREE/RUSTPROOF
INSTALLATION	SUPPLIED WITH A SUITABLE CAGE OR SCREWS



ACCESS DOOR INCLUDED ON ALL 2.5M+ MODELS

CLASSIC POLES UP TO 5000MM

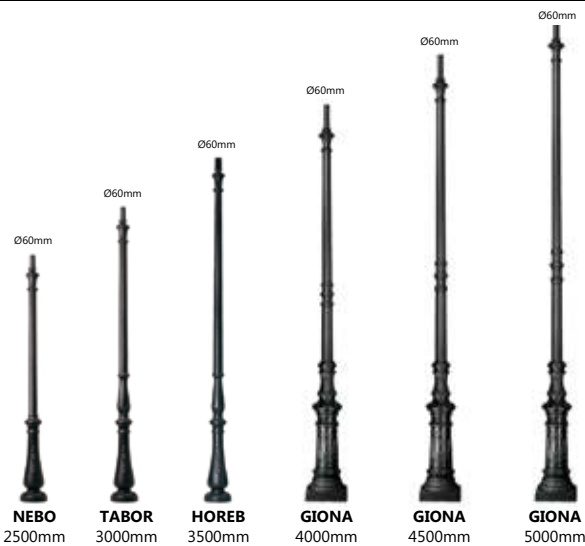

GIONA GLOBE 400



FEATURES



Ø60MM	THE STANDARDISED Ø60MM CONNECTION HUB IS COMPATIBLE WITH ALL FUMAGALLI LANTERNS/BRACKETS
MATERIAL	FUMATECH® STEEL, EXPANSE & RESIN* *EXCEPT WHERE OTHERWISE STATED
FINISH	MAINTENANCE FREE/RUSTPROOF
INSTALLATION	SUPPLIED WITH A SUITABLE CAGE OR SCREWS



ACCESS DOOR INCLUDED ON EKTOR 5000MM POLE

EKTOR BEPPE GREY



EKTOR GINO GREY



EKTOR 3500/5000MM

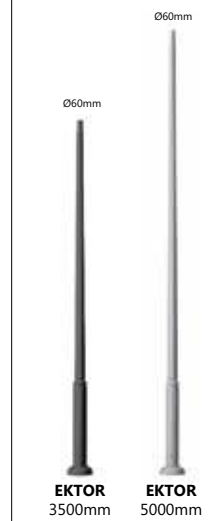

EKTOR GINO 400



Ø60MM CONNECTION

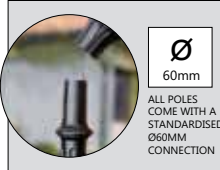

INSTALLATION

ALL POLES INCLUDE A SUITABLE CAGE OR SCREWS FOR INSTALLATION IN CONCRETE FOUNDATIONS.



FUMATECH® TECHNOLOGY



- 1 STRUCTURAL METAL POLE**
GALVANISED INSIDE & OUTBY ZINC BATH IMMERSION
- 2 RIGID EXPANSE**
HIGH DENSITY LIGHTWEIGHT POLYURETHENE FOAM
- 3 OUTER RESIN COATING**
MAINTENANCE FREE & FORMED WITHOUT JOINTS





1.7W DIMENSIONS

POWER	1.7W
LUMENS	170Lm
EFFICIENCY	100Lm/W
CURRENT	17mA
BEAM ANGLE	110°
COLOUR TEMP	3000K 4000K



3W DIMENSIONS

7W / 10W DIMENSIONS

POWER	3W	7W	10W
LUMENS	350Lm	800Lm	1200Lm
EFFICIENCY	116Lm/W	114Lm/W	120Lm/W
CURRENT	30mA	34mA	48mA
BEAM ANGLE	120°	120°	120°
COLOUR TEMP	3000K 4000K	3000K 4000K	3000K 4000K



15W/30W DIMENSIONS

50W DIMENSIONS

POWER	15W	30W	50W
LUMENS	1500Lm	3500Lm	5300Lm
EFFICIENCY	100Lm/W	116Lm/W	106Lm/W
CURRENT	130mA	135mA	210mA
POWER FACTOR	>0.5	>0.9	>0.9
BEAM ANGLE	200°	200°	200°
COLOUR TEMP	3000K 4000K	3000K 4000K	3000K 4000K

MADE IN ITALY
SINCE 1973

INDOOR OUTDOOR

LED

100-240V

50/60Hz

>80

15000h / 25000h

CE

TUV APPROVED

FULLY RECYCLABLE

SILICONE PROTECTION
ENERGY SAVING LED
VOLTAGE 100-240V
POWER FREQUENCY
COLOUR RENDERING
LAMP LIFETIME
EUROPEAN CERTIFIED
TUV APPROVED
FULLY RECYCLABLE



4W/8.5W/11W DIMENSIONS

POWER	4W	8.5W	11W
LUMENS	400Lm	900Lm	1200Lm
EFFICIENCY	100Lm/W	106Lm/W	110Lm/W
CURRENT	75mA	168mA	170mA
BEAM ANGLE	360°	360°	360°
COLOUR TEMP	3000K 4000K	3000K 4000K	3000K 4000K



6W DIMENSIONS

12W DIMENSIONS

POWER	6W	12W
LUMENS	800Lm	1500Lm
EFFICIENCY	133Lm/W	125Lm/W
CURRENT	60mA	100mA
POWER FACTOR	>0.7	>0.7
BEAM ANGLE	360°	360°
COLOUR TEMP	2700K 4000K	2700K 4000K

FULLY RECYCLABLE

TUV APPROVED

EUROPEAN CERTIFIED

25000h

>80

50/60Hz

100-240V

LED

INDOOR OUTDOOR

OFFICIAL DISTRIBUTOR

SILICONE PROTECTION
ENERGY SAVING LED
VOLTAGE 100-240V
LAMP LIFETIME
COLOUR RENDERING
POWER FREQUENCY
EUROPEAN CERTIFIED
TUV APPROVED
FULLY RECYCLABLE

ABOUT ECI LIGHTING



ECI Lighting was originally established as the Electrical Company of Ireland by the Hanratty family in 1960.

In 1968 ECI Lighting opened a state of the art three storey dedicated architectural lighting showroom in Marlborough Street in the heart of Dublin city centre and rapidly became renowned for their knowledge and expertise in the lighting industry.

By the late 1980s the company had become a major distributor of lighting products to the wholesale industry, with sole distributorship of major brands such as Sylvania, Fumagalli, Megaman, Prelux LED and Venture in Ireland.

Today ECI Lighting operates from premises in Dublin, Belfast and Cork while also supplying to a rapidly growing network of wholesale groups in the UK.

Dublin

34/35 North Park, North Road,
Finglas, Dublin 11, Ireland.
T: (01) 860 1860
E: info@ecilighting.ie

Cork

Unit 613, Harbour Point Business Pk,
Little Island, Co. Cork.
T: (021) 488 3434
E: cork@ecilighting.ie

Belfast

3 Duncrue Industrial Park,
Duncrue Road, Belfast BT3 9BP.
T: (028) 9075 6436
E: belfast@ecilighting.co.uk

UK Sales T: 0161 601 7002 | E: uksales@ecilighting.co.uk

T: 00353 1 860 1860 | E: info@ecilighting.ie | W: www.ecilighting.ie



MAINTENANCE FREE RESIN OUTDOOR LIGHTING



YOUR LOCAL FUMAGALLI SUPPLIER



DISTRIBUTED BY ECI LIGHTING

